

A Unit of Teledyne Electronics and Communications

HIGH-TEMPERATURE (200°C), HIGH-PERFORMANCE TO-5 RELAY DPDT

**SERIES
412H
422H
432H**

SERIES DESIGNATION	RELAY TYPE
412H	DPDT high-temperature relay
422H	DPDT high-temperature magnetic-latching relay
432H	DPDT sensitive high-temperature relay

INTERNAL CONSTRUCTION

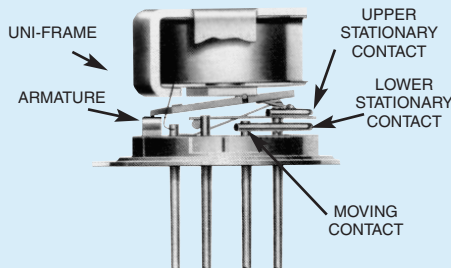

DESCRIPTION

The TO-5 relay, originally conceived and developed by Teledyne, has become one of the industry standards for low-level switching from dry circuit to 1 ampere. Designed for high-density PC board mounting, these TO-5 relays are some of the most versatile ultraminiature relays available because of their small size and low coil power dissipation.

The H Series high-temperature TO-5 relays are designed for reliable operation in elevated ambient temperatures up to 200°C. Special material selection and processing provide assurance of freedom from contact contamination and mechanical malfunctioning that might otherwise be caused by ultra high ambient temperature conditions.

Typical applications:

- Oil exploration (down hole) instrumentation
- High temperature industrial and process control instrumentation

By virtue of its inherently low intercontact capacitance and contact circuit losses, the H Series relays have proven to be excellent ultraminiature RF switches for applications with frequency ranges well into the UHF spectrum (see Figures 1 and 2).

412H 432H		ENVIRONMENTAL AND PHYSICAL SPECIFICATIONS
Temperature (Ambient)		-65°C to +200°C
Vibration (General Note 1)		30 g's to 3000 Hz
Shock (General Note 1)		75 g's, 6 msec, half-sine
Acceleration		50 g's
Enclosure		Hermetically sealed
Weight	412H	0.09 oz. (2.55g) max.
	432H	0.15 oz. (4.25g) max.

422H		ENVIRONMENTAL AND PHYSICAL SPECIFICATIONS
Temperature (Ambient)		-65°C to +200°C
Vibration (General Note 1)		30 g's to 3000 Hz
Shock (General Note 1)		100 g's, 6 msec, half-sine
Acceleration		50 g's
Enclosure		Hermetically sealed
Weight		0.10 oz. (2.84g) max.

PRINCIPLE OF OPERATION 422H

Energizing Coil B produces a magnetic field opposing the holding flux of the permanent magnet in Circuit B. As this net holding force decreases, the attractive force in the air gap of circuit A, which also results from the flux of the permanent magnet, becomes great enough to break the armature free of Core B, and snap it into a closed position against Core A. The armature then remains in this position upon removal of power from Coil B, but will snap back to position B upon energizing Coil A. Since operation depends upon cancellation of a magnetic field, it is necessary to apply the correct polarity to the relay coils as indicated on the relay schematic.

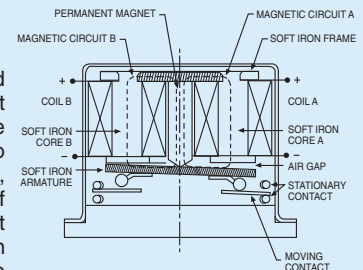

When latching relays are installed in equipment, the latch and reset coils should not be pulsed simultaneously. Coils should not be pulsed with less than rated coil voltage and the pulse width should be a minimum of three times the specified operate time of the relay. If these conditions are not followed, it is possible for the relay to be in the magnetically neutral position.

HIGH-PERFORMANCE

SERIES 412H/422H/432H

GENERAL ELECTRICAL SPECIFICATIONS (-65°C to +200°C unless otherwise noted) (Notes 2 & 3)

Contact Arrangement	2 Form C (DPDT)		
Rated Duty	Continuous		
Contact Resistance	412H/432H: 0.125 ohms max. before life; 0.225 ohms max. after life at 1A/28Vdc 422H: 0.15 ohms max. before life; .25 ohms max after life at 1A/28Vdc } measured 1/8" below header		
Contact Load Ratings (DC) (See Fig. 3 for other DC resistive voltage/current ratings)	Resistive:	1 Amp/28Vdc	
	Inductive:	200 mA/28Vdc (320 mH)	
	Lamp:	100 mA/28Vdc	
	Low Level:	10 to 50µA/10 to 50mV	
Contact Load Ratings (AC) (Note 4)	Resistive:	250 mA/115Vac, 60 and 400 Hz (Case not grounded) 100 mA/115Vac, 60 and 400 Hz (Case grounded)	
Contact Life Ratings (Note 4)	10,000,000 cycles (typical) at low level 1,000,000 cycles (typical) at 0.5A/28Vdc resistive 100,000 cycles min. at all other loads specified above		
Contact Overload Rating	2A/28Vdc Resistive (100 cycles min.)		
Contact Carry Rating	Contact factory		
Coil Operating Power	412H: 450 mW typ. @ 25°C	422H: 290 mW typ. @ 25°C	432H 200 mW typ. @ 25°C
Operate Time	412H: 2.0 msec max.	422H: 1.5 msec max.	432H: 4.0 msec max
Release Time	2.0 msec max.		
Contact Bounce	1.5 msec max.		
Intercontact Capacitance	0.4 pf typical		
Insulation Resistance	10,000 megohms min. between mutually isolated terminals		
Dielectric Strength	Atmospheric pressure: 500 Vrms/60Hz		70,000 ft.: 125 Vrms/60Hz
Minimum Operate Pulse	4.5 msec width @ rated voltage (422H only)		

412H SERIES RELAY

DETAILED ELECTRICAL SPECIFICATIONS (-65°C to +200°C unless otherwise noted) (Note 2)

BASE PART NUMBERS →		412H-5	412H-6	412H-9	412H-12	412H-18	412H-26
Coil Voltage (Vdc)	Nom.	5.0	6.0	9.0	12.0	18.0	26.5
	Max.	5.8	8.0	12.0	16.0	24.0	32.0
Coil Resistance (Ohms ±10% @25°C)		50	98	220	390	880	1560
Pick-up Voltage (Vdc, Max.)		4.7	5.9	9.0	11.9	17.8	24.0
Drop-out Voltage (Vdc)	Min.	0.14	0.18	0.35	0.41	0.59	0.89
	Max.	2.4	3.4	5.1	6.8	10.2	13.5

422H SERIES RELAY

DETAILED ELECTRICAL SPECIFICATIONS (-65°C to +200°C unless otherwise noted) (Note 2)

BASE PART NUMBERS →		422H-5	422H-6	422H-9	422H-12	422H-18	422H-26
Coil Voltage (Vdc)	Nom.	5.0	6.0	9.0	12.0	18.0	26.5
	Max.	5.8	8.0	12.0	16.0	24.0	32.0
Coil Resistance (Ohms ±10% @25°C)		61	120	280	500	1130	2000
Set & Reset Voltage (Vdc, Max.)		4.7	5.9	9.0	11.9	17.8	24.0

432H SERIES RELAY

DETAILED ELECTRICAL SPECIFICATIONS (-65°C to +200°C unless otherwise noted) (Note 2)

BASE PART NUMBERS →		432H-5	432H-6	432H-9	432H-12	432H-18	432H-26
Coil Voltage (Vdc)	Nom.	5.0	6.0	9.0	12.0	18.0	26.5
	Max.	5.8	8.0	12.0	16.0	24.0	32.0
Coil Resistance (Ohms ±10% @25°C)		100	200	400	850	1600	3300
Pick-up Voltage (Vdc, Max.)		4.7	5.9	9.0	11.9	17.8	24.0
Drop-out Voltage (Vdc)	Min.	0.14	0.18	0.35	0.41	0.59	0.89
	Max.	2.4	3.4	5.1	6.8	10.2	13.5

PERFORMANCE CURVES
(NOTE 2)

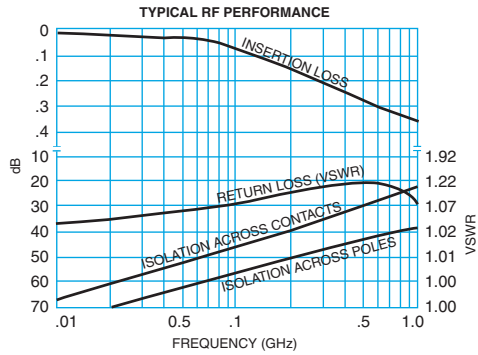

FIGURE 1 (412H AND 432H)

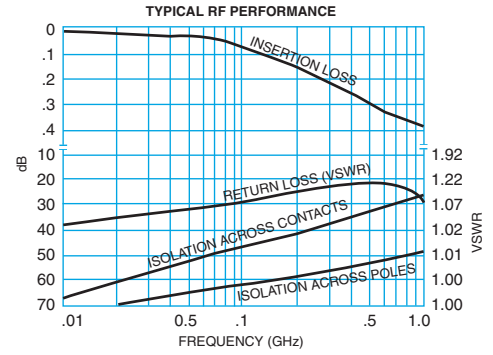

FIGURE 2 (422H)

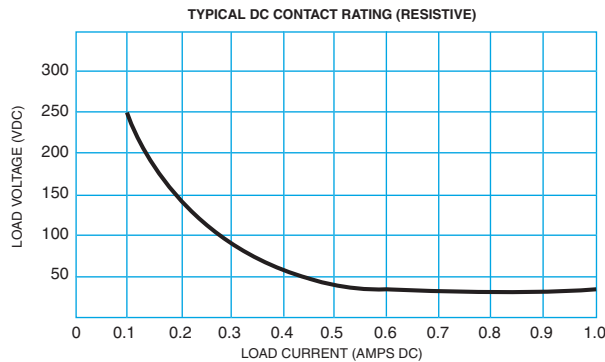
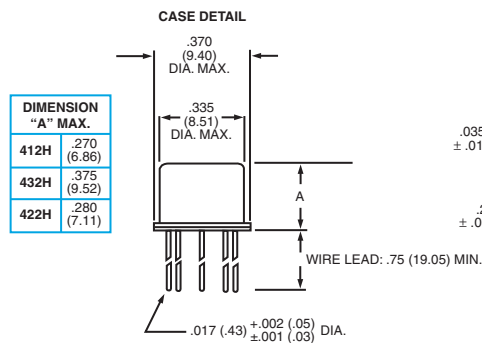
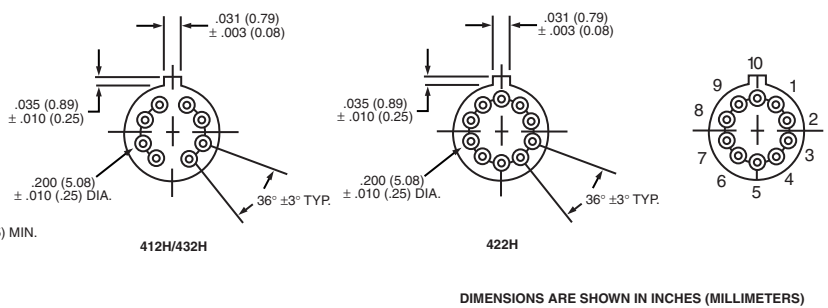

FIGURE 3

OUTLINE DIMENSIONS



TERMINAL LOCATIONS AND PIN NUMBERS (REF. ONLY)
(Viewed from Terminals)



SCHEMATIC DIAGRAMS

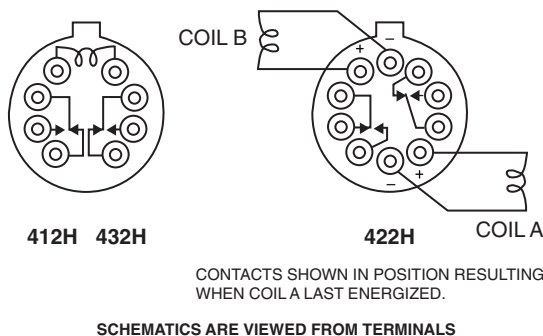

GENERAL NOTES

1. Relay contacts will exhibit no chatter in excess of 10 μ sec or transfer in excess of 1 μ sec.
2. "Typical" characteristics are based on available data and are best estimates. No on-going verification tests are performed.
3. Characteristics are subject to change after life.
4. Contact load ratings and contact life ratings are based on similarity testing at 125°C. No 200°C testing is performed.